

Owner's Manual

for

Sunlawn™

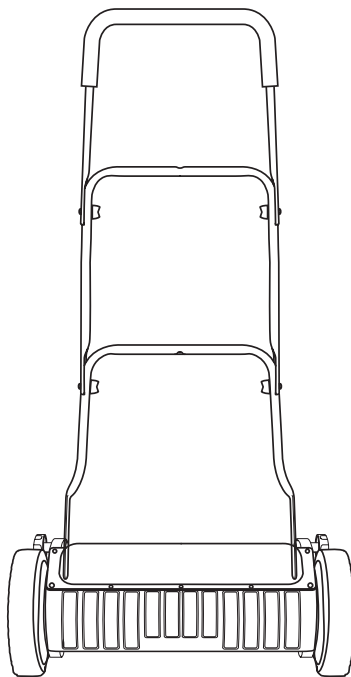

Manual Reel Mower

(Model MM-2)

Table of Contents

Welcome	1
Warranty	1
Use of This Product	1
Assembly	2
Parts List	2
Assemble Handle Section	3
Adjust Cutting Height	3
Operations	4
Inspect Mowing Area	4
Normal Mowing	5
Using Grass Catcher	5
Mowing: General Information	6
1/3 Rule	6
Maintenance	7
Cleaning	7
General Maintenance	7
Storage	7
Re-adjust Blade Clearance	7
Technical Data	8



Sunlawn, Inc.

325 Garfield Street

Fort Collins, CO 80524

Tel: 1-800-282-8850

FAX: 970-493-5202

For service inquiries, parts replacement,
and maintenance tips, see

www.sunlawn.com

© 2006 by Sunlawn, Inc

WELCOME

Congratulations on your purchase of a Sunlawn mower. This and our other Sunlawn products originate from our commitment to *conscientious gardening solutions*. Please use this manual as a reference.

WARRANTY

Sunlawn, Inc. (the Manufacturer) guarantees this product for private use for a period of 2 years from the date of purchase. This guarantee applies to all serious defects of the product which can be proven to have been caused by faulty materials or workmanship. The Manufacturer has the option of supplying a replacement of the product in perfect working order or repairing the product free of charge at an authorized facility, provided that the following conditions are fulfilled:

- The appliance has been handled correctly and in accordance with the instructions in the Owner's Manual.
- Neither the buyer nor a third party has attempted to repair the product.

This guarantee is void if replacement parts or accessories are used other than those approved by the Manufacturer.

The product, accompanied by a copy of the original receipt, must be delivered, prepaid, to a service center authorized by the Manufacturer.

This Manufacturer's guarantee shall not affect any guarantee claims against the dealer or seller of the product.

USE OF THIS PRODUCT

This mower is designed for use on residential lawns. It is not designed for commercial use or for use in public facilities, parks, sporting grounds, roads, or in agriculture or forestry areas.

This mower is for cutting lawns only. It must not be used to trim hedges, bushes or shrubs, for cutting or pruning, or for any mowing where both wheels and the roller are not fully supporting the mower.

ASSEMBLY

PARTS LIST

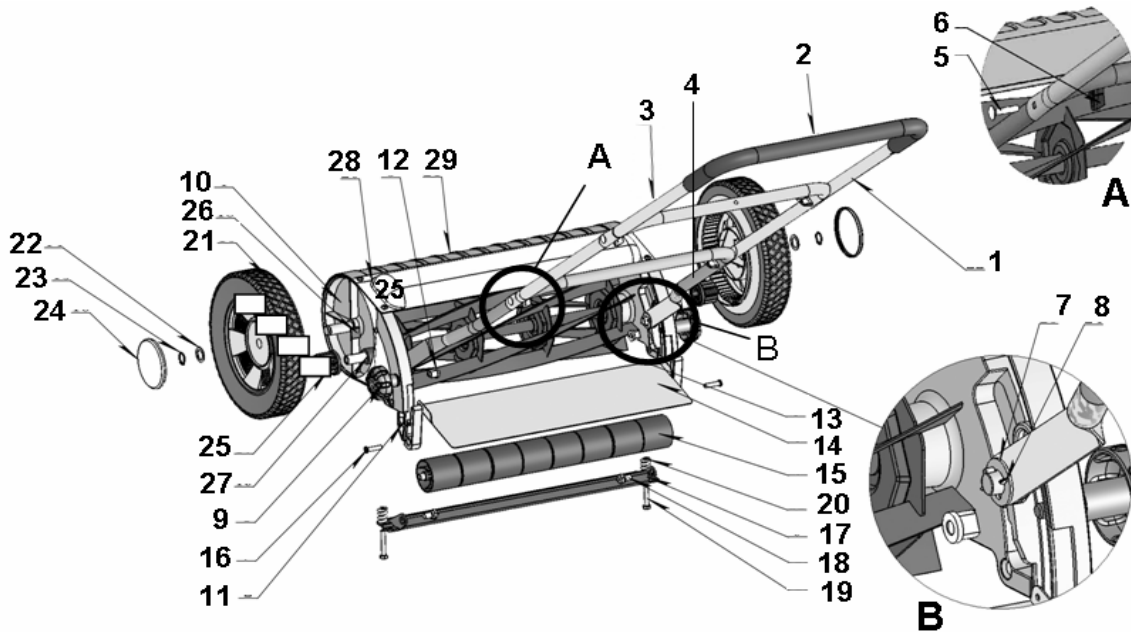

- | | |
|----------------------------|------------------------------------|
| 1. Handle top section | 16. Roller screw (2) |
| 2. Handle grip | 17. Cutting bar |
| 3. Handle mid section | 18. Cutting bar secure bolt (2) |
| 4. Handle lower section | 19. Cutting bar adjusting bolt (2) |
| 5. Handle bolt (4) [A] | 20. Cutting bar spring (2) |
| 6. Handle wing nut (4) [A] | 21. Wheel (2) |
| 7. Handle spacer [B] | 22. Wheel spacer (2) |
| 8. Handle cotter pin [B] | 23. Wheel clip (2) |
| 9. Adjustment knob [B] | 24. Hub cap (2) |
| 10. Side panels (L/R) | 25. Pinion gear (L/R) |
| 11. Adjusting arms (L /R) | 26. Manual drive pawl |
| 12. Compression nut (2) | 27. Spacer (2) |
| 13. Reel blade | 28. Feature cover |
| 14. Catcher apron | 29. Top cover |
| 15. Roller assembly | |

ASSEMBLE THE HANDLE SECTIONS

1. Set the cutting height to the highest setting as shown below. This will make it easier to attach the lower handle section.
 - a. Loosen the two large black knobs [Part # 9], one on each side of the mower body, to allow movement of the height adjustment arms [Part # 11]. NOTE: the handle is mounted to the adjusting arms and thus moves with the arms.
 - b. Set the height to the highest setting and re-tighten the black knobs.

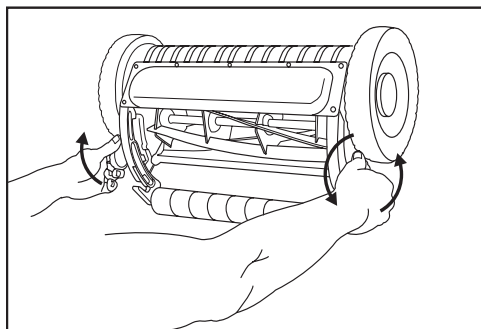

2. Fit the lower section of the handle [Part # 4] so that the holes are over the handle posts on the mower. [See Insert B] Then rock the handle to align the locking tabs and allow the handle section to fit into place. Place the spacer [Part # 7] over the post and put the cotter pin [Part # 8] through the hole to secure the handle.

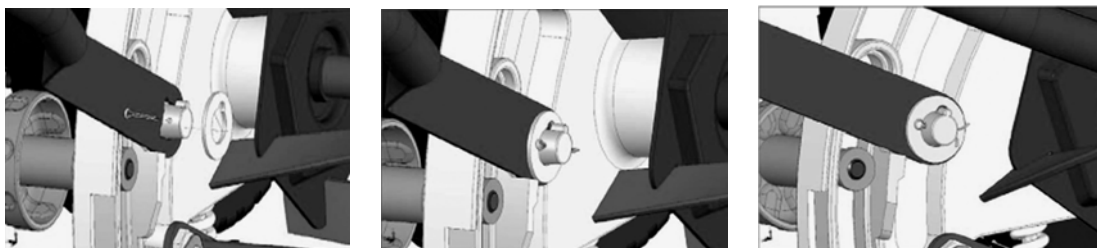

3. Continue assembly of the middle [Part # 3] and top sections [Part # 1] of the handle using the handle bolts and wing nuts [Part # 5 and 6].

ADJUSTING THE CUTTING HEIGHT

The cutting height of the MM-2 may be adjusted from approximately 1.0 inch up to approximately 2.9 inches. Actual height may vary according to the height of the turf. Adjust the mower to the desired height as follows:

1. Loosen the two large black knobs [Part # 9], one on each side of the mower body, to allow movement of the height adjustment arms [Part # 11]. (This is the same movement used to attach the handle.) NOTE: the handle is mounted to the height adjustment arms and thus moves with the arms.

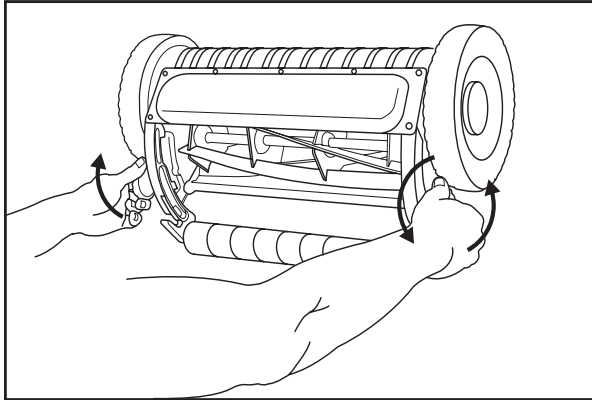

2. Set the height, using the scale on the back of the adjusting arms to the same setting on both sides and re-tighten the black knobs. The mower is now ready to mow at the desired height setting.

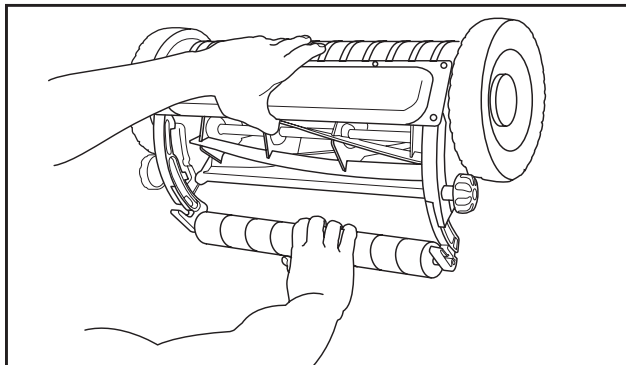

OPERATION

INSPECT THE MOWING AREA

1. Before beginning to mow, remove any foreign objects, such as stones, branches, or toys, from the area.
2. Continue to check for such obstacles during mowing.

The Lawn Should Be Relatively Dry

1. Mowing wet grass causes an uneven cut and can cause damage to the electrical components of the mower.
2. Do not mow when it is raining.



WARNING

- **Before starting the mower, check within the blade area for any foreign objects and remove them.**
- **Do not operate the mower on areas other than turf surfaces. The mower should be sitting upright on a level part of the lawn before starting operation**

NORMAL MOWING

To obtain a clean cut, push the mower in straight lines (passes) at a deliberate walking pace. Overlap the passes to even the cut and to avoid any uncut strips.

MOWING USING THE GRASS CATCHER (OPTIONAL ACCESSORY)

The grass catcher collects the clippings as it mows.

1. Install the catcher apron [Part # 14] on the non-spring pin side
2. Push the spring pin on the other side
3. Install the apron on the spring pin side

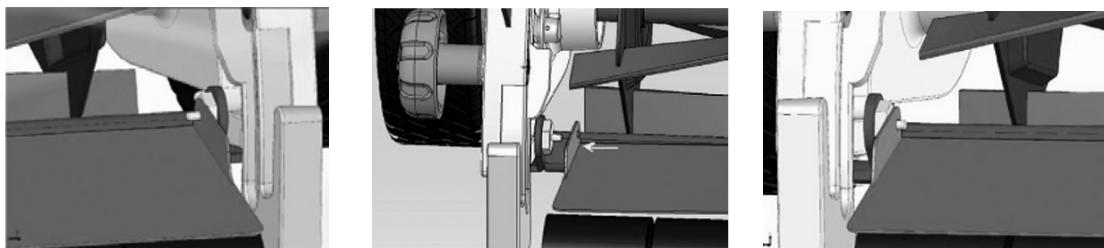

The grass catcher attaches at the grass catcher hooks on the mower and by the strap to the mower handle, as seen below.

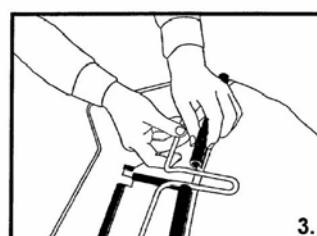
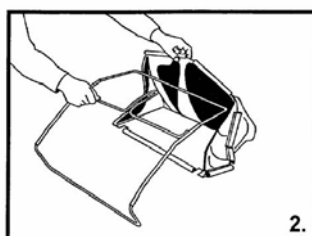
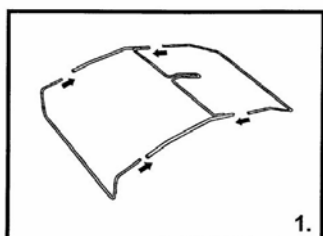

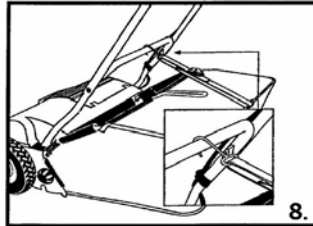
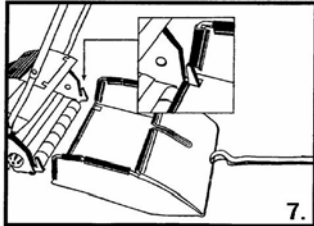
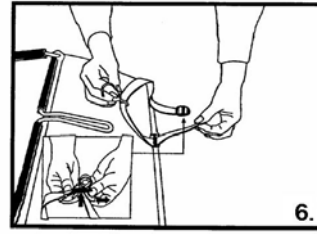
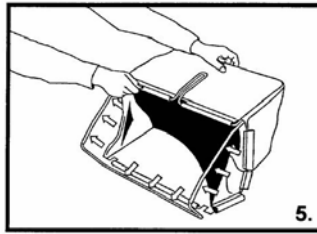
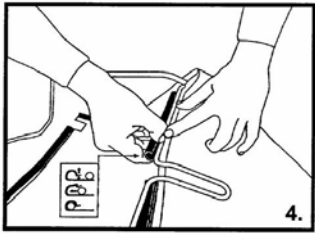

Mow using the same procedure as for normal mowing (described above).

MOWING: GENERAL INFORMATION

THE 1/3 RULE

This is the key to enjoyable mowing and a healthy lawn.

1. The lawn should be mowed regularly, at least once a week during the growing season.
2. Be guided by observing the lawn and taking care not to remove more than 1/3 of the total height of the turf at any mowing.
3. Following this rule will stimulate the turf's root growth, maintain its health, and encourage its natural ability to crowd out unwanted weeds.

If the lawn has become too high (over 4 inches in height) then it is best to set the mower to the highest setting to mow. After mowing, reset down to the normal level and mow again within a day or two.

Removing too much of the turf's height, especially in the heat of summer, can cause root shock and weaken the lawn; bringing down the height by successive mowings over two or more days can avoid this damage and maintain the health of the turf.

If the lawn is overgrown (to higher than 4 inches) it may be advisable to use a brush cutter to remove the excess turf mass before resuming mowing at normal heights.

MAINTENANCE

CLEANING

After using the mower, clean with a moist cloth. Spray the cylinder and cutting bar with silicon spray lube.

GENERAL MAINTENANCE

Regularly check to insure that all bolts, nuts, and screws are tight and that the mower is in good working order. Worn out and damaged parts should be replaced.

The blades, if properly cared for, will mow for years before requiring sharpening. **Sharpening can only be done by a professional using a cylinder grinder and proper techniques.**

STORAGE

1. Store the MM-2 in a cool, dry place.
2. The mower should be stored out of the reach of children.

READJUSTING THE BLADE CLEARANCE

The blades are optimally adjusted from the factory. However, after using the mower for a long period, if the cut is not clean, the blades need readjusting. The procedure is as follows:

1. Turn the mower over to expose the cutting bar on the bottom of the mower. [Part # 17].

Using a 10mm open end wrench, tighten the hex bolt approximately 1/4 turn [Part # 19] at one end of the cutting bar until the cutting bar and cylinder come into contact. Spin the blade cylinder by hand and back off the bolt approximately 1/8 turn or until the cutting bar and cylinder are no longer in contact.

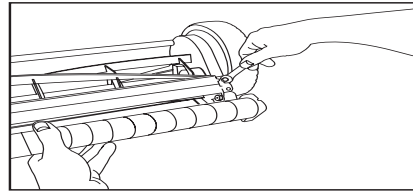
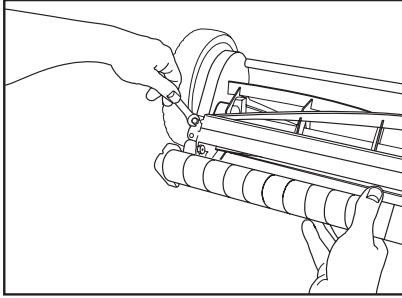

2. Make the same adjustment at the other end of the cutting bar.
3. Now check the adjustment using the small 0.05mm/0.002 inch gauge (silver strip) supplied with the MM-2 (or any 0.05mm/0.002 inch feeler gauge). If the gauge is held by the cylinder blades but the cylinder and cutting bar are not touching then the adjustment is correct.

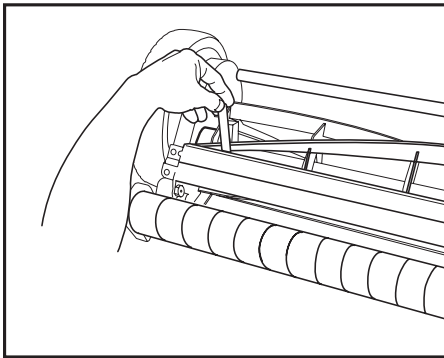

4. The blades may also be tested by inserting a piece of paper vertically into the blades while turning them by hand.



WARNING

Blades are sharp! Be careful of injury — handle the blades carefully to avoid cutting yourself. Wear appropriate gloves or hand protection.

TECHNICAL DATA

Mower	Cutting width:	40 cm (16 inches)
	Cutting height rough (from floor):	1.0 to 2.9 inches